

MASTER SALT SAND SPREADER WIRELESS CONTROL MANUAL

This manual covers

1. Gas spreader wireless controllers (Standard)
2. Gas spreader wireless controllers (Plus)
3. 600DC single motor spreader wireless controllers
4. 625DC single motor spreader wireless controllers with vibrator option
5. 650DC dual motor spreader wireless controllers

Our Wireless control units are proven to be more cost effective and more reliable than hard wired controller systems. However clean, solid and correct connections of all wiring is required.

It is very important to follow installation directions very carefully. Salt spreaders require regular maintenance. If you do not keep your units clean and greased and do not follow the manufactures maintenance requirements you are almost guaranteed to have problems.

When any of these units are not in use the power must be disconnected from the unit, via a switch or quick disconnect (not provided).

Gas Spreader Wireless Controllers (Standard)- These will work on any gas engine driven v-box spreaders that have an all in one electric throttle choke combination actuator. MOST ALL UNITS BY WESTERN, MEYER, SWENSON, HINIKER, DOWNEASTER, MONROE, HENDERSON, HINIKER, SALT DOGG and more use this type of actuator on the engine.

Gas Spreader Wireless Controllers (Plus) All functions the same as the Standard but also has two additional momentary functions, example (use for units with separate electronic chokes,) and has a optional latching on off button, to use with a automotive relay for a vibrator, lights,

600DC Single Motor Spreader Wireless Controllers

These units are typically used on tailgate or receiver hitch mounted spreaders with single motors up to 1/2 HP. You may use power and ground from your 7 prong plug (see directions) for motors up to 1/3 HP. For motors over 1/3hp you must run a separate power and ground cable direct from your battery. It must be at least 6 gauge wiring. These units work with all single motor units with up to a 1/2hp motor and without a vibrator. (SEE 625DC for Vibrator option.

625DC Single Motor Spreader Wireless Controllers

Same as 600DC unit but also has an additional on/off vibrator control fuction. THIS UNIT MUST GET POWER AND GROUND DIRECTLY FROM THE BATTERY AND NOT THROUGH A 7 PRONG TRAILER PLUG.

650DC Dual Motor Spreader Wireless Controllers

These units work with most dual motor electric driven spreaders. This will eliminate expensive module boxes, wiring and hardwired controllers. Vibrators or other options will need to remain hard wired.

Programming instructions (note your unit comes pre-programmed and tested)

FIG 1

ADD Button
Depress with
Paperclip lightly



Blue LED flashes

Programming instructions for all units are below, pictures used may not match your individual unit.

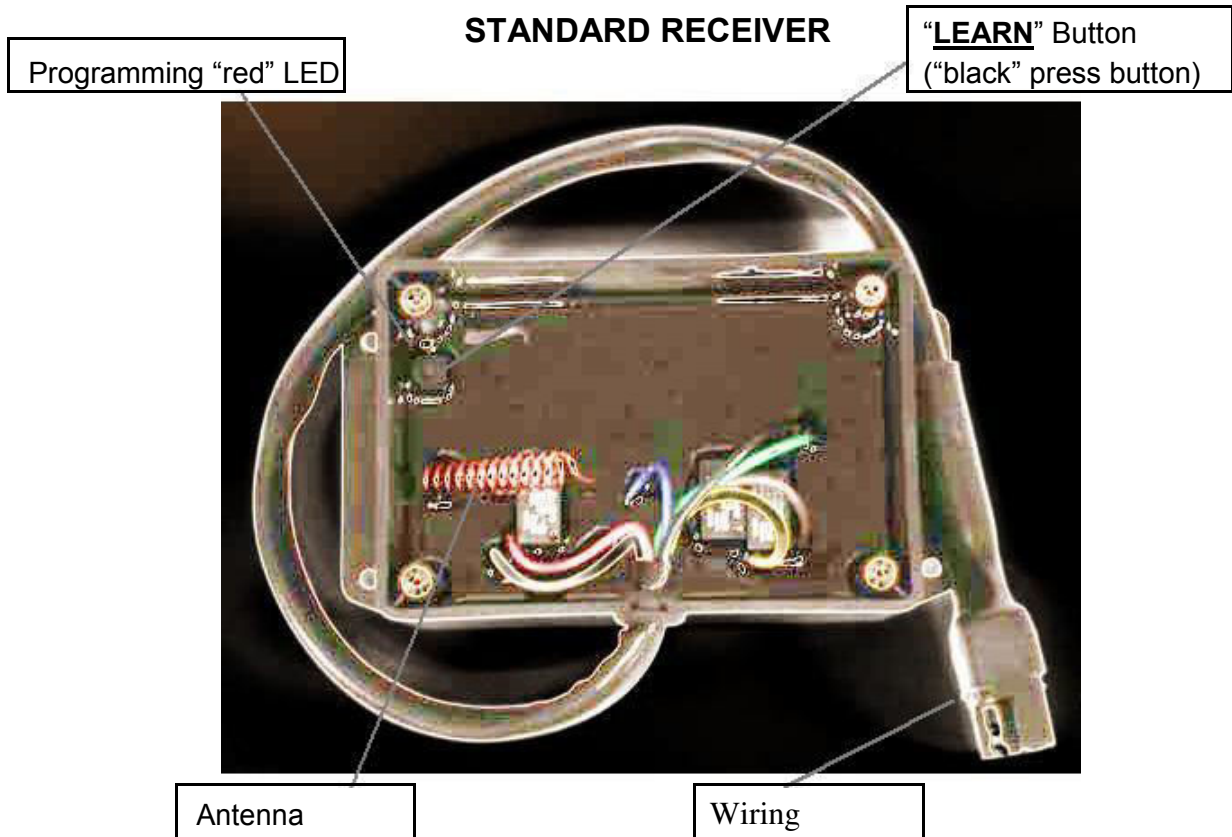

Fig. 2: Base Unit layout (Figure shown without Base Unit Cover)

Programming/Reprogramming the Transmitter and the Base Unit:

Tools needed: A small "phillips" screwdriver and a small diameter pin (paper clip). Instructions to program Transmitter and Base Unit:

1. Remove (4) screws and cover on Base Unit.
2. Power-up the Base Unit. Connect a 12V power source to the spreader 12V battery terminals DO NOT DISCONNECT THE BATTERY TERMINALS from the 12V source when engine is running (gas only).
3. On the backside of the Transmitter depress the "**ADD**" button (see Fig. 1) using a small pin or paper clip – You will see a "blue" LED start to blink (for approximately 15-17 seconds).
4. On the front side of the Transmitter press all (8) buttons (see Fig. 1). There is no certain order to press the buttons. Firmly press each button, separately. Perform this step before the 15-17 seconds are up (before "blue" LED stops blinking). The Transmitter is now programmed and has created its own 1 in 16 million address. Once the "blue" LED stops blinking, this step is completed.
5. On the Base Unit (see Fig. 2) press the black "**LEARN**" button. The "red" LED will start to blink (for approximately 15-17 seconds).
6. On the front side of the Transmitter press all buttons one at a time again. Perform this step before the 15-17 seconds are up (before "red" LED stops blinking). The base unit has now recognized the Transmitters unique 1 in 16 million address. Once the "red" LED stops blinking, this step is completed.
7. Verify all the functional buttons on the Transmitter are working with the Spreader Unit by pressing each button, individually (the Base Unit "red" LED will flash when a Transmitter button is pressed). If Transmitter buttons are not working, repeat steps 3 – 8 or see the Trouble shooting directions.
8. When Transmitter buttons are functioning properly, re-assemble the Cover on the Base Unit with the (4) screws. Your Wireless Controller is now ready to use!

Transmitter Battery Replacement

The Transmitter uses a standard CR2032 lithium button cell battery. In normal use it will provide 1 to 2 years of operation. To replace the Transmitter battery, gently press and slide the battery cover off. Remove the battery by sliding (NOT lifting) it out from underneath the retainer (see Fig. 4). Observe the battery polarity when replacing (“+” showing face up). Notes:

1. If the battery loses power or is removed the Transmitter and Base Unit may need to be reprogrammed (see reprogramming Transmitter and Base Unit instructions). Check Transmitter functional buttons to verify if reprogramming is necessary.
2. When removing lithium battery, please use caution to slide not lift the battery from the controller! If excess force is used to remove the battery (example: lifting the battery with a small screw driver) – the solder connections from the battery clip to the circuit board could be pried loose. This action is not covered under warranty.

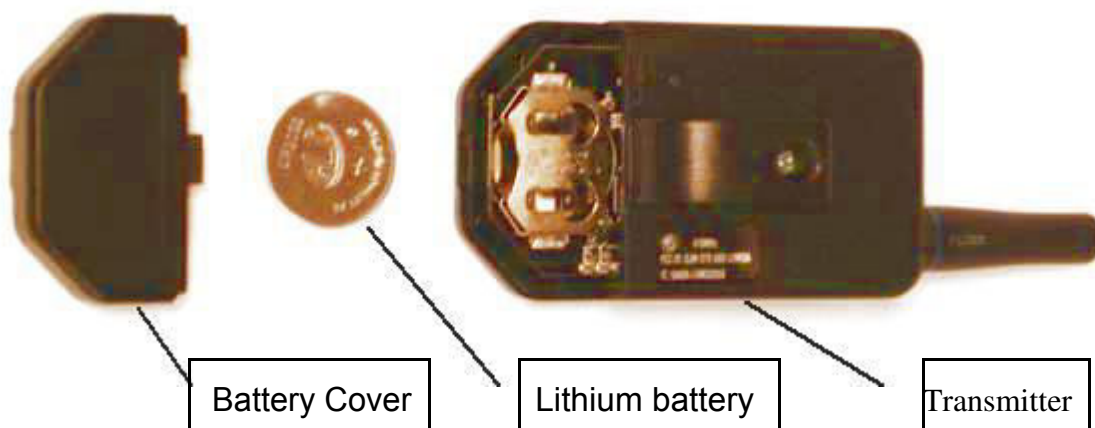

Fig. 4: Back of Transmitter with back cover and battery removed

Other Considerations

1. **Powering off the engine will not automatically power off the Clutch** (engagement of conveyor/spinner). If clutch remains engaged, after engine is turned off, it could lead to a slow electrical drain on the 12V battery. (Gas engine models only)
2. **If an unregulated voltage** (example: sparking the battery cable terminal to the 12V battery post.) **is sent to the Base Unit it could erase the Base Unit programming.** The remote may show signs of no longer working with the Base Unit. Reprogramming will be required. When 14Amps are supplied the Base Unit circuit board is designed to shut off. See additional trouble shooting comments.
3. **Only one transmitter at a time can be activated within a reception area.** Only one carrier of a particular frequency may occupy the same airspace at a given time. This means that if two transmitters are activated in the same area at the same time the signals will interfere and the decoder on the receiver will not see a valid transmission and the wireless controller will not function.
4. **Multiple Transmitters** can be programmed to (1) Base Unit.
5. To verify the Base Unit is receiving a signal from the Transmitter. Press a button on the Transmitter - “red” LED on the Base Unit will light-up.
6. We have no control over the intended usage of this product. Because of that we offers no written or expressed liability as to how this product is used.
these units are intended for OFF ROAD USE ONLY!

TROUBLESHOOTING ALL UNITS

1. **To verify the Transmitter and Base Unit are working together:** Once the base unit has power the "red" LED will come on when the Transmitter buttons are depressed (Cover of Base Unit will need to be removed to see "red" LED). If the "red" LED does not come on, the Base Unit is NOT getting a signal from the Transmitter.

Possible Solutions:

- A. Reprogramming the Transmitter and Base Unit might be required.
- B. Base Unit might not be functioning properly (see Base Unit trouble shooting below).
- C. Transmitter might not be functioning properly. (see Transmitter trouble shooting below).

2. **Base Unit Programming Lose:** If an unregulated voltage (spark) is sent to the Base Unit from a power source the Base Unit could lose its programming. The voltage spike will not damage the Base Unit or Transmitter. Unregulated voltage could generate from the following:

- Connecting battery cables to a 12V battery source.
- Jump starting the 12V battery.(Gas engine models only)
- Charging the 12V battery.
- Pull-starting the engine.(Gas engine models only)

Possible Solutions:

- A. Reprogramming the Transmitter and Base Unit may be required.
- B. Base Unit might be damaged, a new Base Unit & Transmitter will need to be ordered.

3. **Base Unit does not function properly:** (example: "red" LED will not light up when "**LEARN**" button is depressed on Base Unit).

Possible Solutions:

- A. Check/verify voltage of 12V is being supplied by the 12V battery. Lower voltages than 12V will not allow the Base Unit to function properly.
- B. Confirm all wires on engine wire harness are secure and properly connected.
- C. Base Unit could be damaged, a new Base Unit & Transmitter will need to be ordered.

4. **Transmitter does not have power:** (example: "blue" LED will not light up when "**ADD**" button is depressed on Transmitter).

Possible Solutions:

- A. Verify tool diameter (example: paperclip) to depress Transmitter "**ADD**" button is small enough to enter the "**ADD**" button hole.
- B. Verify the lithium button cell battery polarity is correct ("+" will be facing up).
- C. If the Transmitter is 1-2 years old, check the lithium battery voltage with a meter or replace the battery as needed (CR2032 lithium button cell battery).
- D. Transmitter could be damaged, a new Transmitter will need to be ordered.

5. **General troubleshooting:**

- A. Try to Program/reprogram the Transmitter and Base Unit.
- B. Verify the Ground wires (all wires) are secure.
- C. Check connections to the components that the unit is trying to operate using a voltmeter.

WARNING (GAS ONLY) Disconnecting 12V Battery Cables/Terminals: DO NOT DISCONNECT THE BATTERY (CABLES/TERMINALS) WHEN THE ENGINE/MOTOR IS RUNNING. This could disable or permanently damage the Base Unit.

WARNING PLEASE READ THIS FOR ELECTRIC SPREADER APPLICATIONS.

THESE UNITS ARE DOUBLE TESTED BEFORE THEY SHIP AND WORK WHEN THEY LEAVE HERE. IF YOU HOOK THE UNIT UP AND IT DOES NOT WORK CHECK YOUR POWER AND GROUND CONNECTIONS. DO NOT TAKE THE TRANSMITTER APART 95% OF THE TIME IT IS A POOR POWER OR GROUND CONNECTION.

FAILURE TO FOLLOW ALL DIRECTIONS CAN LEAD TO PERMANENT DAMAGE TO EITHER MOTOR, CONTROL, TRANSMITTER OR ALL.

Salt spreaders are made for salt only, not sand, granite chips... Salt spreaders have small motors and will burn out if overloaded. If you drive a distance with a fully loaded hopper before activating any controls go back to the spinner and turn it counterclockwise and then clockwise to free up any compaction before activating the controller. **If you do not do this and continue to apply power to the motor you will burn out the motor and possibly the controller. THIS IS NOT COVERED UNDER WARRANTY.**

If you cannot turn on the unit check your power and ground first, then make sure there are no jams and the spinner, auger, conveyor move free.

VIBRATORS SHOULD ONLY BE RUN FOR SHORT PERIODS OF TIME.

DISCONNECT ALL POWER FROM THE UNIT WHEN NOT IN USE TO AVOID ENHANCED CORROSION OF WIRING.

(BE SURE OF YOUR GROUND AND POWER SOURCE BEFORE CONNECTING WIRES) Make sure you do not reverse the ground and power as you will burn out the receiver.

USE DIELECTRIC GREASE ON YOUR ELECTRICAL CONNECTIONS TO PREVENT CORROSION. TYPICAL TAILGATE MOUNTED SPREADERS HAVE 2 BEARINGS MAKE SURE TO GREASE THEM OFTEN.

Note: It is recommended that you install a switch on the power or ground wire of your power supply (battery) so you can shut off the power when the unit is not in use. Wiring that is left powered all the time enhances corrosion of wiring. A switch will also prevent battery drain when not in use.

Gas Engine SPREADER OPERATION

Standard Wireless Throttle Control Button Functions (Sequence of Operations)



A. ON/Off System power activated (ready to start). Spreader engine not running. Spreader conveyor is not engaged.

B. START (Engine Only)

1. Open fuel shut off valve on engine. CHOKE (Cold engine.) Hold down for 5 seconds to move the throttle actuator to the choke position.

NOTE: Choking a warm engine may not be necessary.

2. START Hold down button until engine starts.

3. TURTLE Decreases throttle speed - adjust as engine warms up. Will stop the choke function.

RABBIT Increases throttle speed.

C. TO ENGAGE SPREADER CONVEYOR

1. CONVEYOR Push CONVEYOR switch only after you are sure no one is in the hopper or near the spinner!

D. TO CONTROL CONVEYOR SPEED

1. RABBIT Hold RABBIT to increase speed.

Note **DO NOT** hold switch in HI position after the desired RPM is achieved or you will choke and/or stall the engine.

2. TURTLE Hold TURTLE to decrease speed.

E. TO DISENGAGE SPREADER CONVEYOR

1. CONVEYOR Push conveyor button.

F. TO TURN ENGINE OFF (With or without conveyor running).

1. TURTLE

2. STOP

NOTE: OFF can be pushed at anytime during spreader operation to cut power to the unit; however, you should normally use steps under F above.

G. Do not attempt to start the engine with the conveyor engaged.

H. Close fuel shut off valve on engine if unit is to be transported while not running.



WARNING!

1. As with all power equipment, safety is the number one concern.
2. Do not operate this equipment until you fully understand how it functions.
3. Before starting engine, be sure that no one is near the rear of the unit and that no one is inside the unit!
4. Do not start the engine or engage the conveyor (which is interconnected to the spinner) until everyone is clear from moving parts and flying material from the spinner.

Gas Engine unit continued

Spreader Standard Wireless Controller For use with Gas Engine packages

The wireless controller is a compact unit with two parts. One part is the **Base Unit (Receiver)** and the other part is the **Transmitter (Hand Held Controller)**. The Transmitter is used to send a corresponding

signal to the Base Unit to act as a remote switching device. The Wireless Controller comes factory programmed. That means matching the Base Unit to the Transmitter has been done by the factory. This gives a matched (1 of 16 million combinations @ 418MHz) interface between the Transmitter and Base Unit. See Figures 1 & 2 for Transmitter button assignments. On the 8 button Spreader Transmitter, all (8) buttons are used when programming.

Set-up and Operation

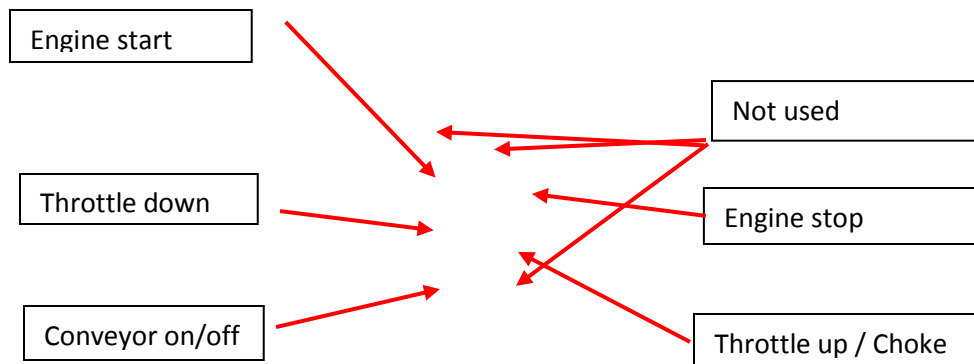

END GAS ENGINE MANUAL

GAS SPREADER PLUS MANUAL

This unit has been tested and transmitter programmed.

Wiring Installation Diagram for GASSPREADERPLUS

ATTENTION IF THE ENGINE DOES NOT HAVE A VOLTAGE REGULATOR ON IT AT NO TIME SHOULD THE BATTERY CABLES BE DISCONNECTED OR JUMPER CABLES, CHARGERS ... BE USED WHILE HOOKED UP TO THE REMOTE UNIT. . **USE THE ENCLOSED 10 AMP IN-LINE FUSE ON THE RED POWER WIRE.** IF THE BATTERY CABLES BECOME DISCONNECTED THE ENGINE WILL SEND OVER 60 VOLTS TO THE RECEIVER UNIT AND BURN THE UNIT OUT which voids 60 day warranty. No warranty on burnt circuit boards.

Use a test light to locate the proper oem wires for connection to the wireless unit.

Kit includes

1-receiver base unit

1-transmitter

1-10amp in line fuse link

Yellow wire is activated by button #1 Latch/Unlatch conveyor / spinner on off (L)

White wire is activated by button #2 Momentary (optional use with relay)

Green wire is activated by button #3 Throttle control (throttle UP) (U) button

Blue wire is activated by button #4 Throttle control (throttle DOWN) (D) button

Brown wire is activated by button #5 Momentary engine start (E) button

Orange wire is activated by button #6 Momentary to ground/kill motor (STOP) button

Purple wire is activated by #7 Momentary (optional for accessories use with relay)

Yellow/black wire is activated by button 8 (optional latching , use as on off switch for vibrator lights ... use with a relay)

Red wire is DC power supply

Black wire is DC ground

MAKE SURE YOU HAVE SECURE AND CLEAN CONNECTIONS EVERYWHERE

This unit will replace your oem controller. Before installing locate and be familiar with the original equipment wiring to assist in where to attach the wires from this unit.

No more than 12 amps total at any given time can run through the receiver. We recommend the use of 6-10 amp diodes on the control wires to prevent any power feedback into the receiver. For higher amp uses you must use relays... with the unit. It is recommended to wire in a on off switch on the power (red wire) of the receiver to prevent battery drainage when the unit is not in use.

Intended usage:

We has no control over the end usage of the wireless units.

Because of this, We recommend that these units are intended for OFF-ROAD use only. We offers no written or expressed liability as to how this unit is used

Set-up and operation

All controllers come factory programmed. This gives a matched (1 of 16 million combinations @ 418MHz interface between the Transmitter and base unit.

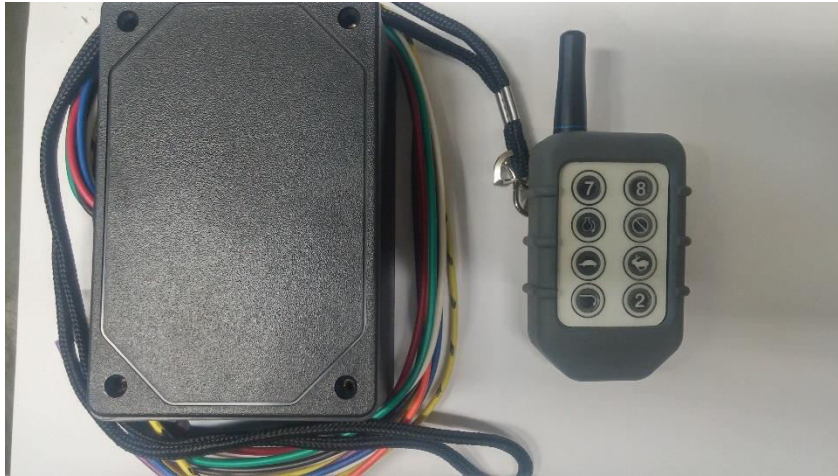

Note: buttons 2,7,8 are shown blank but are used by options per directions.

END GAS SPREADER PLUS MANUAL

600DC SINGLE MOTOR WIRELESS CONTROL MANUAL

OPERATION:

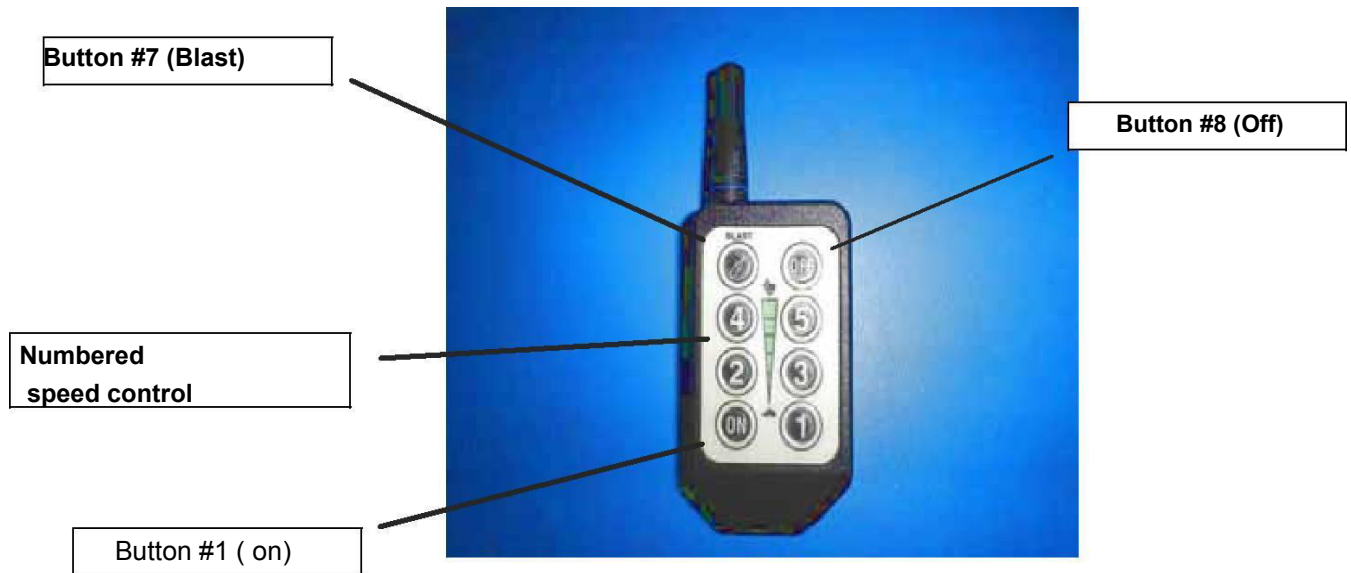

VARIABLE SPEED TRANSMITTER

Shown above is a typical transmitter for wireless operation of a 12VDC motor. The button functions are as follows:

1. **ON/** This button turns on the receiver unit and will allow the receiver to function. It also will stop the unit, but does not shut down the receiver.
2. **#1/** Slow speed setting of approximately $1/5^{\text{th}}$ of full motor speed.
3. **#2/** Speed setting or approximately $2/5^{\text{th}}$ of full motor speed.
4. **#3/** Speed setting or approximately $3/5^{\text{th}}$ of full motor speed.
5. **#4/** Speed setting or approximately $4/5^{\text{th}}$ of full motor speed.
6. **#5/** Full Speed.
7. **Blast/** A timed 6 to 8 second full speed with auto shut down.
8. **OFF/** Shuts down the receiver unit. Must be turned on using Button #1

600DC SINGLE MOTOR WIRELESS CONTROL MANUAL

READ CAREFULLY BEFORE AND WHILE INSTALLING

NOTE FOR MOTORS LARGE THAN 1/3HP YOU CANNOT USE POWER AND GROUND FROM YOUR 7 PRONG TRUCK PLUG EXAMPLE Meyer Blasters, must run 6 gauge from battery

Many 2014 and newer trucks do not have large enough guage wiries to provide proper power to the unit you must run power and ground from the battery on these vehicles.

600DC1 INTERNAL COPPER ANTENNA BLUE STRIPE TRANSMITTER

NOTE TRANSMITTER HAS BEEN PROGRAMMED TO THE RECEIVER SEE PAGE 4 FOR PROGRAMING INSTRUCTIONS.

For use with 12 volt DC only

600DC1 INTERNAL COPPER ANTENNA BLUE STRIPE TRANSMITTER Wireless Variable Speed DC Motor Controller

How it Works:

The 600DC1 Wireless DC Motor Controller provides RPM control for a single, 2 pole DC motor that can output up to over 100 amps for up to 1 seconds and a continuous amperage of up to 75 amps. The speed or RPM control is done by providing the user 5 outputs, approximately 1/5 of the maximum motor RPM. The 600DC1 also incorporates a full RPM feature (Blast) that runs the motor full speed for 6 to 8 seconds and then automatically shuts off and an E-Stop.

To protect the motor and electronics, the 600DC1 has built-in safety circuits. These include:

- Automatic shut down if motor is locked up. How this is done is if the receiver senses a current draw of more than 100 amps at start up for more than approximately 1000mS, the unit will shut down from 1 to 30 seconds.
- Automatic shut off if the current draw does not drop below 75 amps after 6 to 8 seconds. Once again, the receiver will shut down for 1 to 30 seconds.

Typical Wiring Connection Diagram

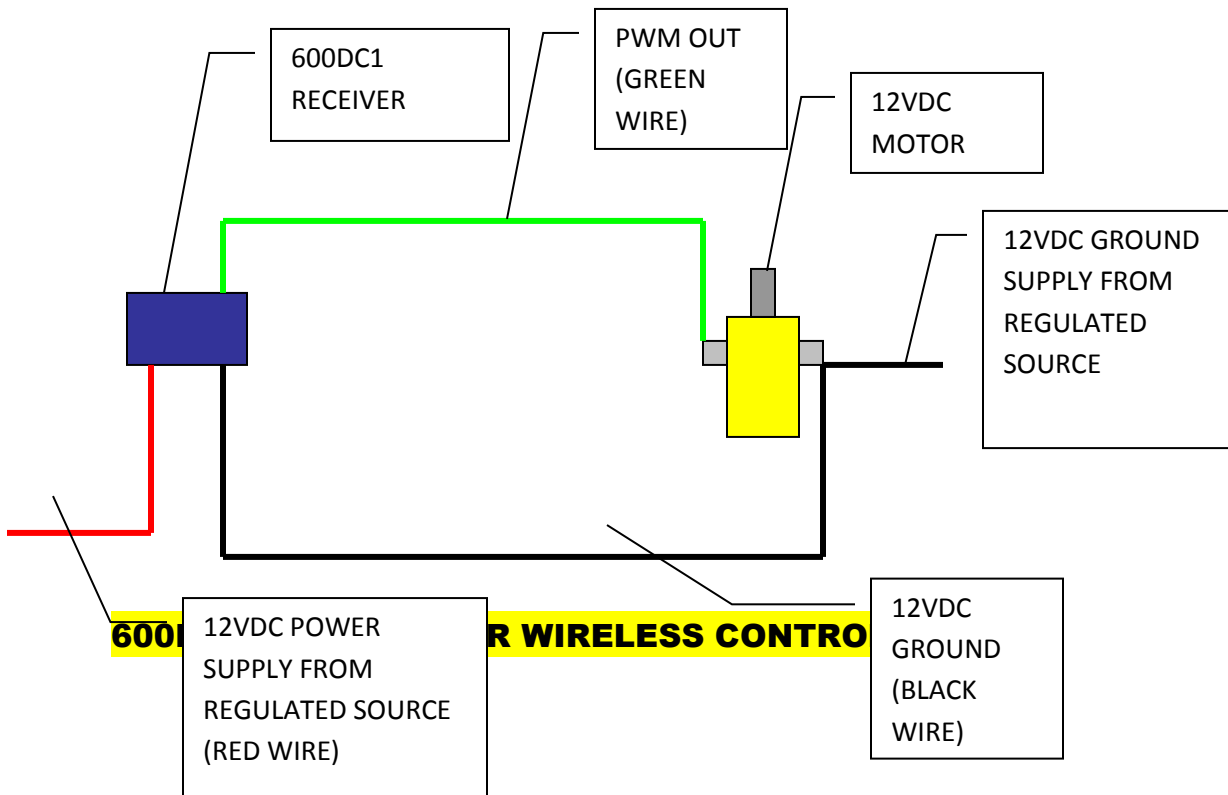

We highly recommend the use of Alumiconn #18 - #10 awg connectors only. Or secondly USE DIELECTRIC PACKED WIRE NUTS OR DRYCONN NUTS FOR ALL CONNECTIONS. MUST USE A MINIMUM OF 10 GAUGE WIRE FOR POWER

RED WIRE FROM RECEIVER CONNECTS TO POWER SOURCE 12V POSITIVE OR 7 PRONG TRUCK TRAILER PLUG IN POSITIVE WHICH IS LABELED BLACK #4 ON INSIDE OF TRUCK 7 PRONG RECEPTACLE..

BLACK WIRE FROM RECIEVER (GROUND) CONNECTS TO BLACK WIRE ON MOTOR AND GROUND OF POWER SOURCE OR GROUND ON 7 PRONG TRUCK RECEPTACLE LABELED WHITE #1

GREEN WIRE FROM RECEIVER CONNECTS TO RED WIRE OF MOTOR.

TYPICAL TRUCK PLUG IS SHOWN BELOW. USE POSITION 4 THE POWER SOURCE AND POSITION 1 FOR THE GROUND SOURCE.

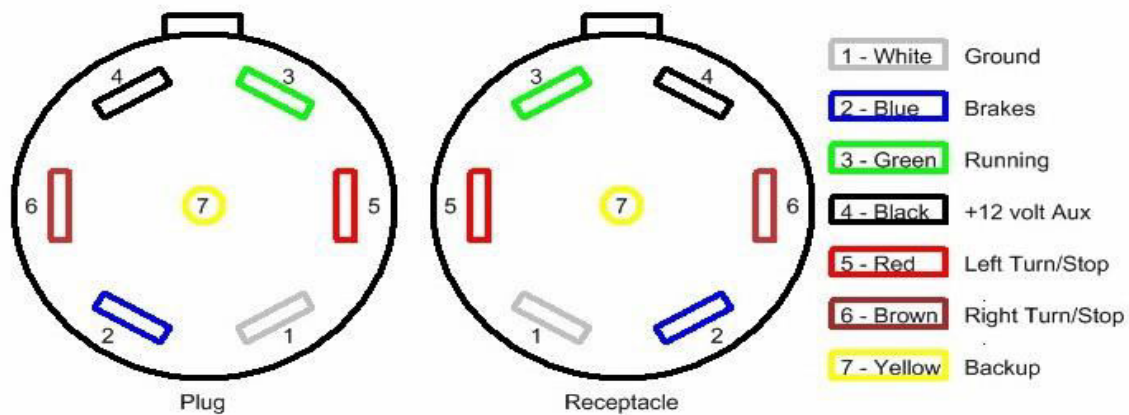

If your unit came with or you purchased a 7 prong female plug lead we use the white(ground) and black(power) wires only. The rest of the wires are not used.*User must maintain good, clean connections for proper operation and to avoid damage to the receiver and void the warranty*** NOTE YOU CANNOT USE THE 7 PRONG CONNECTOR TO POWER MOTORS OVER 1/3HP. **END 600DC MANUAL****

625DC MANUAL WITH VIBRATOR OPTION

625DC1 typical use is for a SINGLE MOTOR SALT SPREADER WITH VIBRATOR CONTROL.

NOTE TRANSMITTER **HAS** BEEN PROGRAMMED TO THE RECEIVER SEE PAGE 4 FOR PROGRAMING INSTRUCTIONS AND TROUBLESHOOTING.

For use with 12 volt DC only

625DC1 Wireless Variable Speed DC Motor Controller

How it Works:

The 625DC1 Wireless DC Motor Controller provides RPM control for a single, 2 pole DC motor that can output up to over 1500 amps for up to 1 seconds and a continuous amperage of up to 75 amps. The speed or RPM control is done by providing the user 4 outputs, approximately 1/4 of the maximum motor RPM. The 625DC1 also incorporates a on off vibrator function or can be used for a light etc...

To protect the motor and electronics, the 625DC1 has built-in safety circuits. These include:

- Automatic shut down if motor is locked up. How this is done is if the receiver senses a current draw of more than 100 amps at start up for more than approximately 1000mS, the unit will shut down from 1 to 30 seconds.
- Automatic shut off if the current draw does not drop below 75 amps after 6 to 8 seconds. Once again, the receiver will shut down for 1 to 30 seconds.

Typical Wiring Connection Diagram

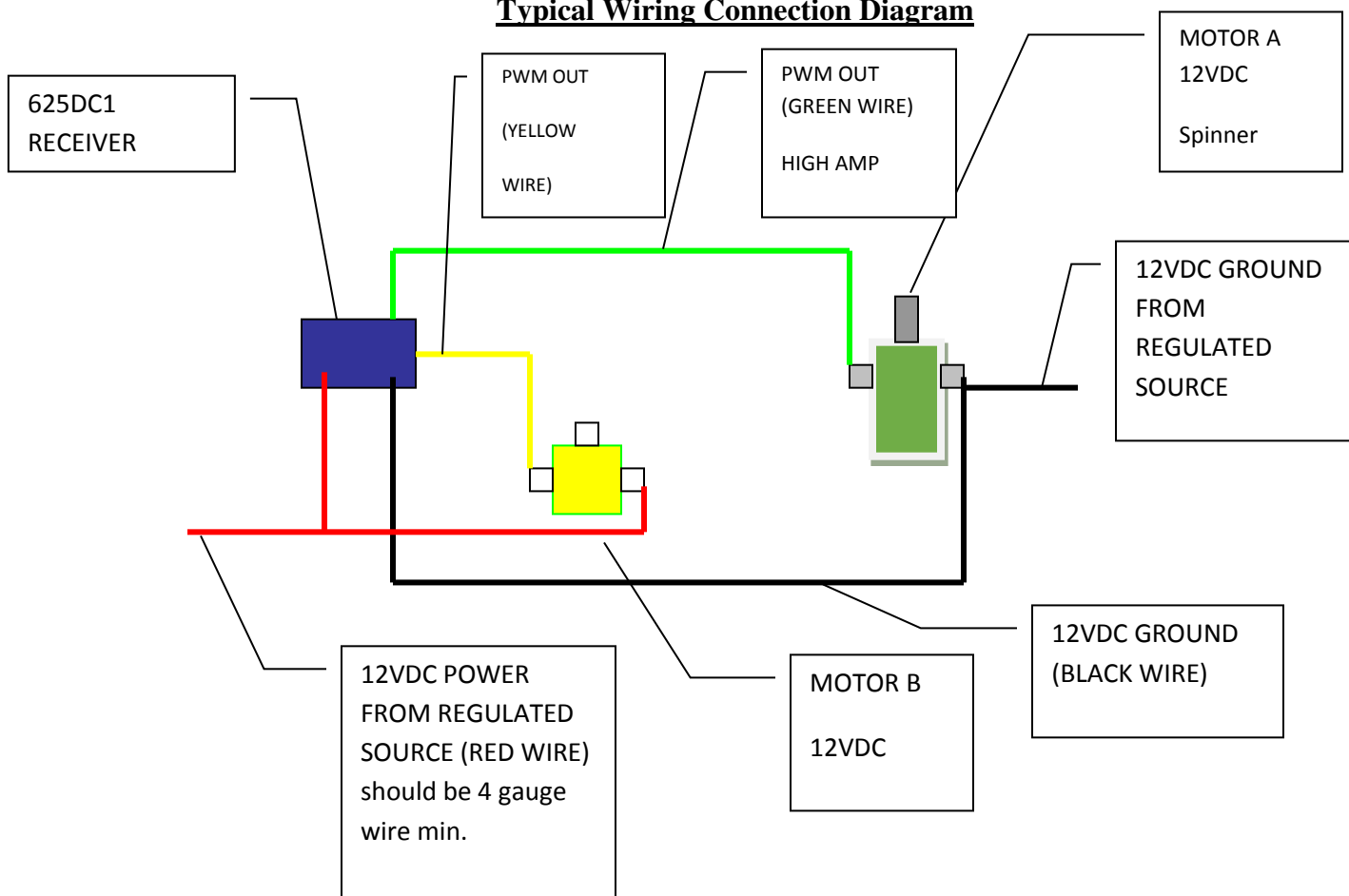

625DC MANUAL WITH VIBARATOR OPTION

We highly recommend the use of Alumiconn #18 - #10 awg connectors only. Available at snowplowsplus.com

Do not use the 7 prong plug on your truck as power and ground for this unit. You need to run a minimum of 6 gauge wire (power and ground) directly from your battery to the unit.

Connect the red wire from the receiver to the power source and to 1 post on the vibrator motor.

Connect the black wire from the receiver to the ground source and to 1 post on the spinner motor.

Connect the yellow wire from the receiver to the open post on the vibrator

Connect the green wire from the receiver to the open post on the spinner motor.

Transmitter operation- Note button 8 is a on off single button for the spinner only.

Or secondly USE DIELECTRIC PACKED WIRE NUTS OR DRYCONN NUTS FOR ALL CONNECTIONS. MUST USE A MINIMUM OF 10 GAUGE WIRE FOR POWER

*****User must maintain good, clean connections for proper operation and to avoid damage to the receiver and void the warranty*****

625DC MANUAL WITH VIBRATOR OPTION

OPERATION:



**625DC1 blue ringed
TRANSMITTER not actual**

Shown above is a typical transmitter for wireless operation of a 12VDC motor. The button functions are as follows:

- ON VIBRATOR** This button turns the vibrator on
- OFF VIBRATOR** This button turns the vibrator off
- ON/OFF** shuts down the spinner only
- Numbered buttons-** speed control

****** It is recommended that when the DC motor/s is under high loads that the control first be started at medium to high speed for the first 1 to 5 seconds of operation to avoid damage to the motor or control and may void the warranty******

END 625 DC MANUAL

650DC DUAL MOTOR CONTROLLER.

For use with 12 volt dc voltage only

650DC1 Wireless Variable Speed Dual DC Motor Controller

How it Works:

The 650DC1 Wireless Dual DC Motor Controller that provides RPM control for 2 single, 2 pole, DC motors that can output up to 200 amps to Motor A (Larger motor or conveyor or auger motor) and up to 100 amps to Motor B (smaller motor or spinner motor) for up to 1 second and a maximum continuous amperage of 75 to Motor A (larger) and up to 40amps to Motor B(smaller). The RPM control is done by providing the user 2 separate outputs, approximately 1/3 of the maximum motor RPM for each motor. The 650DC1 also incorporates a full RPM “Blast” feature that runs both motors full speed for 6 to 8 seconds and then automatically returns to the previous speed and an E-Stop.

To protect the motor and electronics, the 650DC1 has built-in safety circuits.

- Automatic shut down if motor is locked up. How this is done is if the receiver senses a current draw of more than the rated amps for more than approximately 1000mS the unit will shut down from 1 to 30 seconds and must be restarted using button #8.
- Automatic shut off if the current draws do not drop below the rated amps after 5 to 7 seconds. Once again, the receiver will shut down for 1 to 30 seconds.

Typical Wiring Connection Diagram

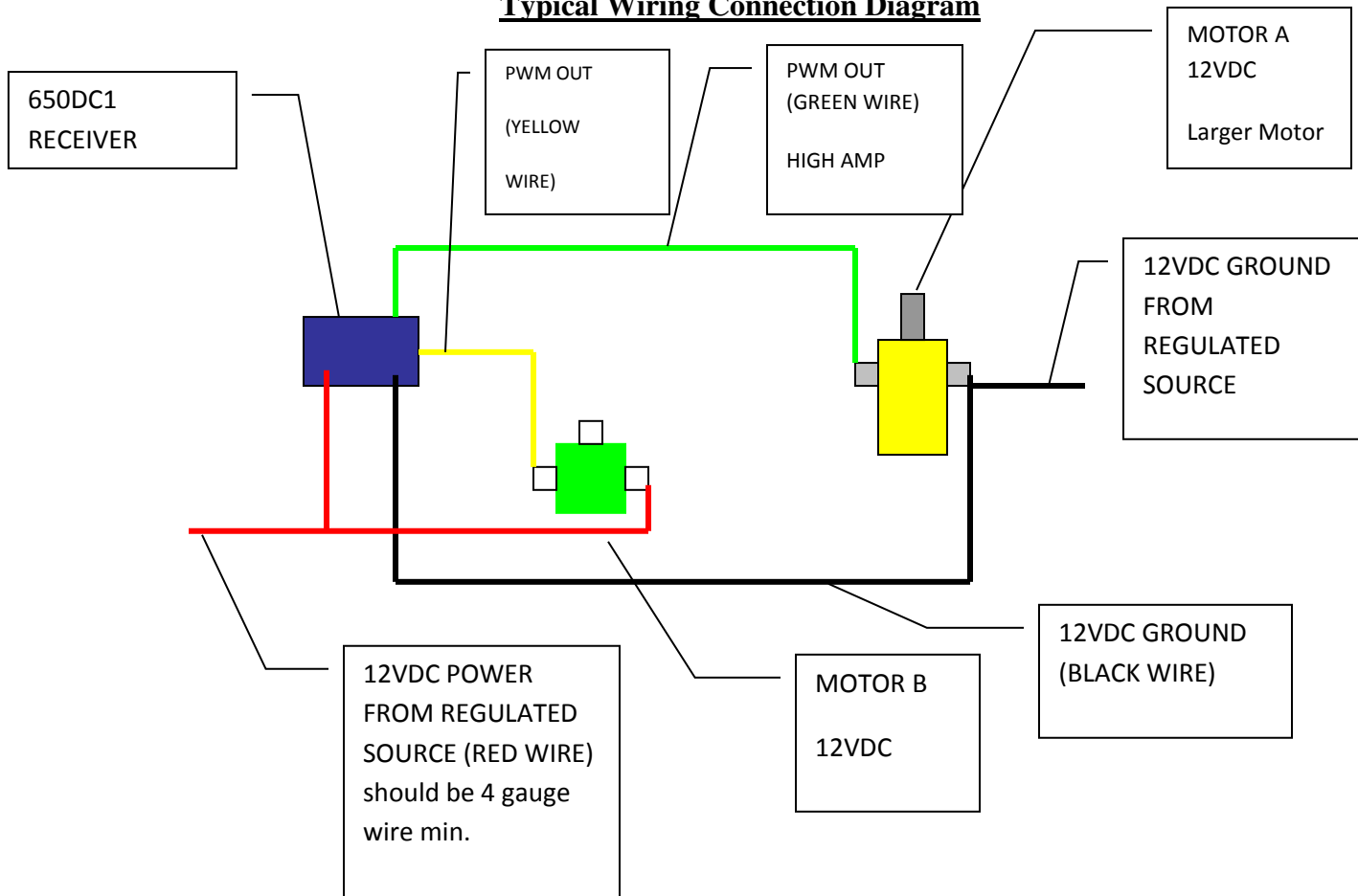

WIRING DIRECTIONS

Note you must wire per directions it might look like you are applying power to both sides of Motor B but you are not. Use a a disconnect on the main power wire when unit is not in use to avoid wire corrosion.

Motor A is in reference to your larger motor typically the auger or conveyor motor which is typically a ½ HP motor.

Motor B is in reference to your smaller motor typically the spinner motor up to 1/3 hp

Use weather proof secure connectors with dielectric grease for all connections.

Your ground wire needs to come from the battery and can typically be a 6 or 8 gauge wire.

The ground wire will connect to both the black wire (some motors may have two of the same color wires or unlabeled terminals, If so if you hook up the wires wrong the motor will run in the opposite direction, simply switch the wires to switch the direction of the motor) of motor A and also to the black wire of the wireless receiver.

Connect the Green Wire from the wireless receiver to the Red wire of Motor A (If no red wire then connect to the open post or wire If motor runs in reverse switch the wires)

Connect the Yellow wire from the wireless receiver to one of the posts or wires on Motor B

The last connection you should make is from your 12vdc battery to the red wire of the wireless receiver and also to the other open post or wire on Motor B.

Use at least an 8 Gauge wire from your 12vdc battery to the wireless receiver. A good rule is to use one or two sizes larger gauge wire than what the larger motor takes for your main power feed.

Check online for any updated directions at www.snowplowsplus.com

*****User must maintain good, clean properly connected connections for proper operation and to avoid damage to the receiver and void the warranty*****

OPERATION:



650 STANDARD TRANSMITTER

Shown above is a typical transmitter for wireless operation of a 12VDC motor. The button functions are as follows:

1. Slow speed setting of approximately 1/3rd of full speed of Motor "A" (Conveyor or Auger Motor).
2. Slow speed setting of approximately 1/3rd of full speed of Motor "B" (Spinner Motor).
3. Medium speed setting of approximately 2/3rd's of full speed of Motor "A".
4. Medium speed setting of approximately 2/3rd's of full speed of Motor "B".
5. Full speed setting of approximately 3/3rd's of full speed of Motor "A".
6. Full speed setting of approximately 3/3rd's of full speed of Motor "B".
7. **Blast/** A timed 6 to 8 second full speed to both Motors with return to previous speed
8. **OFF/** Shuts down the receiver unit. Must be turned on again using Button #8
9. **** It is recommended that when the DC motor/s is under high loads that the control first be started at medium to high speed for the first 1 to 5 seconds of operation to avoid damage to the motor or control and may void the warranty****

END 650 WIRELESS MANUAL